

AIR CREATION

PARTS CATALOG

FREQUENTLY REPLACED PARTS





## TABLE OF CONTENTS

Air Filters, silencer, hose.....	59
Bearings and Bushings.....	32
Brake Components.....	16
Cloth Products, Bunji, Roap.....	23
Dual Controls and Training Bars.....	62
<a href="#">Electrical</a> .....	8
Exhaust and parts.....	60
Fasteners.....	20
Front End, Fenders, Etc.....	66
Fuel System Components.....	12,13,14,15
Gaskets & Seals.....	24
Gerbing Heated clothing.....	41
Hoses, and Lines and Fittings.....	46- 49
Instruments and Accessories.....	30
Kits.....	26
Landing Gear Components.....	63
Lights and Strobes.....	43
Mast and Hardware.....	57
Oil System Components.....	10
Parachute Parts.....	55, 56
<a href="#">Plastic Parts</a> .....	4
Propellers.....	44
Ram Mount Hardware.....	51
Radiators/parts.....	58
Radios, Intercom, and Accessories.....	50
Rubber Products.....	68
Seats and Hardware.....	54
Seat Belts and harness.....	42
Shocks & Shock Mounts.....	18
Starter Components.....	34
Steering Components.....	52
Tires, Tubes, Wheels.....	28
Water Cooling System.....	58
Wheel Pants.....	
Windsheilds.....	53
Wing Parts.....	36,37,38

**Plastic Components**



**DART RECEPTICLE  
P313110 A-8**



**GROMMET 6-25-17 AIRSPEED IND.  
P342510 A-19**



**LOCKING PIN DART  
70MM: P313020 A-3  
GTE WINDSHEILD  
ARV LUGGAGE  
ARV WINDSHEILD  
WASHER: P313210 A-3  
50MM: P313005 A-69  
ARV TURTLE**



**SQUARE DART RECEPTICLE  
P313120 A-4**



**Batten Fork: P232010 Black A-2  
P 232020 Red A-2**



**FRONT LOWER CABLE SLEEVE  
S402010 A-14**



**P231010: A-1 BATTEN TIP Ø10 BLACK  
P231020: A-1 BATTEN TIP Ø10 RED**



PART #:



**P233010 A-8 STOP BATTEN  
I351410 A-27 RIVET**

**Plastic Components**

	<p>P300610 M6 P300810 M8 P301010 M10 P301210 M12</p>		<p>M8: P310810 A3 M10: P311010 A3</p>
<p>PART #:</p>	<p><b>WING HEAD</b></p>		
	<p><b>NYLON Cup 054</b> P355010 A-7</p>		
<p><b>RAP STOP RING Ø54</b> D263010 A-24</p>			
<p><b>MUD GUARD FLAP (GTE RACER)</b> R081220</p>	<p><b>GEAR FRONT STRUT BEARING</b> E132010 B-3</p>		
			
<p><b>SPLITTER BASCULE</b> E303050 A-18</p>	<p><b>LAUNCHING PULLEY</b> R062020 A-18</p>		
			
<p><b>E135510 A-5</b> <b>PEDAL RING 14-6.2-14</b></p>	<p>PART #:</p>		

### Plastic Components



**R101010  
FOOTREST JACKET**



**E134010  
ARP LOCK WASHER 80MM**

PLASTIC WASHERS

6-14: B820610 A-56  
10-18-1.5 B821018



**E303020  
UNDERCARRIAGE BUSHING**



**C361010  
NEVER KINK A-6**



**E138550  
GTE FRONT TUBE BASE A-32**









**E131010 A-74  
SHOCK ABSORB TUBE SHOULDER**

**E131511 A-74  
51MM WHEEL LEG SHOULDER**

**Plastic Components**

<b>P205410 B-16 CAP 054</b>	<b>P202810 B-16 FINNED PLASTIC CAP 028</b>
<b>P206010 B-16 BUTTERFLY CAP 060</b>	<b>P204510 B-16 FINNED PLASTIC CAP 045</b>
<b>P202010 B-16 FINNED PLASTIC CAP 020</b>	<b>P205010 B-16 FINNED PLASTIC CAP 050 RACER WING</b>
<b>P202510 B-16 FINNED PLASTIC CAP 025</b>	<b>P205510 B-16 FINNED PLASTIC CAP 055 2-PLACE WING</b>
<b>P202510-3 B-16 FINNED PLASTIC CAP 025-3</b>	

### Electrical Components

	<p><b>KEYS A-88</b></p> <p><b>KEY SWITCH X221010 A-88</b></p>	 <p><b>IGNITION KEYS X221012 A-88</b></p>
	<p><b>MAG SWITCH R181310 A9</b></p>	<p><b>R181810 SWITCH CAPS A-9</b></p>
	<p><b>IGNITION SWITCH R181510 A9</b></p>	<p><b>SOCKETS AND PINS?????</b></p> <p><b>X202010 8 9IN PLUG CASE X201010 8 PIN SOCKET CASE</b></p>
	<p><b>X281010 80 AMP FUSE A9</b></p>	<p><b>X2</b></p>
	<p><b>E304130 SWITCH PROTECTOR</b></p>	 <p><b>E304040 FUSE BOX MOUNT</b></p>



### Electrical Components

**E307129**  
**FUSE BOX PROTECTOR**

PART #:



**STARTER SOLENOID**  
**F992818 A67**

PART #:



**X210500 FUSE HOLDER BOX A10**



**KEY WEST PS030 REGULATOR/RECTIFIER**  
**SPRUCE PART# 11-03168 C27**



**X208152 LIGHTER RECEPTICLE A10**

PART #:

PART #:

PART #:

### Oil System Components



**ROTAX 912 OIL FLITER  
F825706 A-16**

PART #:

**ROTAX 912 OIL FLITER  
F825706 A-16**

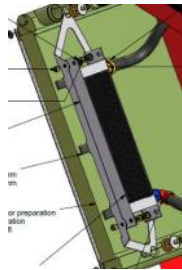

PART #:

PART #:

PART #:

PART #:

### Oil System Components

	PART #:
PART #:	PART #:
PART #:	PART #:
PART #:	PART #:
PART #:	PART #:

**Fuel System**



**GAS FLITER STRAIGHT  
R131110 B-12**



**FUEL PRIMER PUMP  
R132008 B-5 (6MM) B-5  
R132010 B-5 (9MM) B-5**

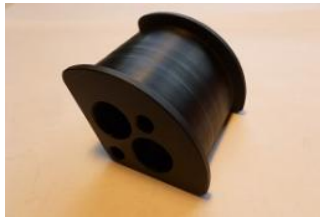

**SPLITTER BASCULE  
E303050 A-18**



**GTE SPLITTER  
R142800 A-68**



- 1 meter - Carbopress Hose R132512
- 2 - Plastic T 06-6-6 R130560
- 1 - Manual Pump R132008
- 1 - 90 Plastic connector 06 R130545
- 8 - Clamp 14.0 GER R138010

**FUEL BYPASS KIT  
PART #:**

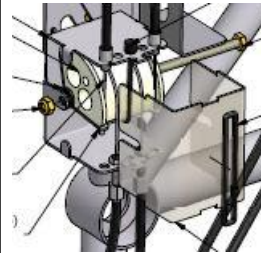

- CABLES:**
- R151032 N2 TO CARB
  - R151030 N1 TO CARB
  - R151056 HAND THROTTLE
  - R151051 FOOT THROTTLE
  - R149915 BACK THROTTLE

**SPLITTER KIT A-95 Z304012**



- 1EA E314054 TUBE PVC SPLITTER
- 2EA R142832 SPLITTER PART 1
- 2EA R142830 SPLITTER PART 2
- 1EA 206075 THREADED ROD M6X75MM
- 4EA B800610 M6 NYLSTOP NUT
- 4EA 820610 6-14 NYLON WASHER
- ??EA R144010 ADJUSTABLE STOP SHEATH
- ??EA NYLON SET SCREWS

- 1EA E304015 SPLITTER STOP
- 1EA E306010 SPLITTER COVER
- 1EA E304012 SPLITTER SUPPORT
- 1EA E303050 SPLITTER BASCULE A-18
- 1EA B270670 M6x70 SCREW
- 1EA B800610 M6 NYLOC
- 2EA B820510 6-13-2 PLASTIC WASHER
- 2EA V281010 ELASTIC SPRING
- 1EA B199010 SHEETMETAL SCREW
- 1EA X106110 ROUND LUG A-9

**Fuel System**



**R130710**  
**60L TANK CAP A-16**



PART #:

**R130720**  
**60L TANK CAP GASKET A-16**

**R130410**  
**FUEL SHUT OFF VALVE A-23**



**P346006 6MM**  
**GROMET FOR PRE-**  
**FILTER A16**

**P346010**

**E302175**  
**FUEL TANK PRE-FILTER A87**

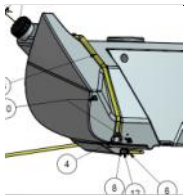

**TANARG SITE TUBE**

**R133028 polyurethane hose Ø10-16 L460**  
**P346010 rubber bushing Ø10 2ea**

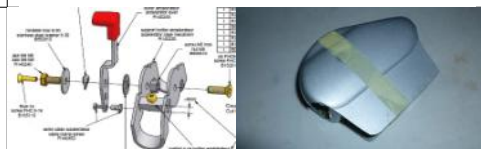

RIGHT CLICK IMAGE OPEN  
HYPERLINK FOR DETAILS:

**R140400 LEVER THROTTLE FAIRING**  
**R140230 ACCELERATOR LEVER**  
**R1400220 ACCEL CASE MECHANISM**



**R130732**  
**FUEL GAUGE 17GAL FOR TANARG A65**

**Fuel System**



**F861620  
PRIMWE KIT A21**



**JBM INTAKE PORT PLUG  
A18**



**MIKUNI DUAL CARB REBUILD KIT  
CPS PART # 07-01010 B18**



- 125 145
- 130 150
- 135 155
- 138
- 140

**MISC CARBURATOR JETS B-17**



- 1EA E314054 TUBE PVC SPLITTER
- 2EA R142832 SPLITTER PART 1
- 2EA R142830 SPLITTER PART 2
- 1EA 206075 THREADED ROD M6X75MM
- 4EA B800610 M6 NYLSTOP NUT
- 4EA 820610 6-14 NYLON WASHER
- ??EA R144010 ADJUSTABLE STOP SHEATH
- ??EA NYLON SET SCREWS

R132512  
CARBOPRESS HOSE 6-12



- ALSO ORDER:**
- 840 740 NIPPLE 7/3.8
  - 840 745 NIPPLE 9/5.7
  - 252 425 GASKET RING 10.2/15/1.5

**983 115 FUEL PUMP ASSEMBLY  
FOR SERVICE BULETIN SB-912-063**

## Fuel System



- 1EA R132512 CARBOPRESS 06-12 50MM
- 2EA B042010 CHC 4X20 A33
- 1EA O041210 DUAL CONTROL TROTTLE LEVER E-2
- 1EA O041010 DUAL CONTROL TROTTLE STOP E-2
- 1EA R144310 ADJUSTABLE STOP SHEATH A17
- 4EA O041110 NYLON SPACER

COMPLETE ASSEMBLY E-2

PART #:

PART #:

PART #:

PART #:

**Brake System Components**



**BRAKE TORQUE PLATE  
R024020**



**BRAKE DISC Ø180  
R024136**



**R035095 A-68  
PADS FOR CALIPER R035024/26**



**NEW TANARG DISC  
R024137**



**OLD BRAKE CALIPER  
LEFT R035020-M / RIGHT R035022-M**

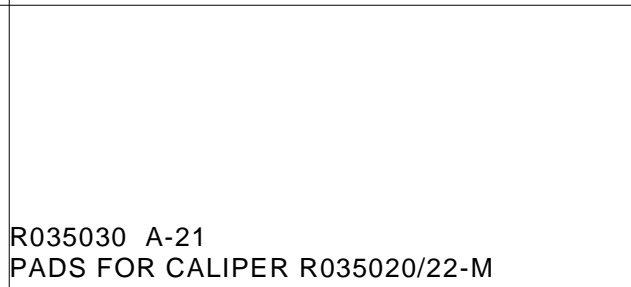

**R035030 A-21  
PADS FOR CALIPER R035020/22-M**



**NEW BRAKE CALIPER A-86  
LEFT R035024 / RIGHT R035026**



**GTE BRAKE CABLE  
R143010**



**GTE FRONT BRAKE CABLE ASSEMBLY  
R141510 SHEATH  
2EA R144105 SHEATH STOP  
R144210 SHEATH END  
R144010 ADJUSTABLE SHEATH STOP  
B805610 STAINLESS STEEL NUT M6  
R143010 BRAKE CABLE  
C321610 NICOPRESS 1.6**



### Brake System Components



**TANARG MASTER CYLINDER (OLD)  
R035010**

**SKYPPER MASTER CYLINDER  
R035052 REPLACED R035050**

**TANARG MASTER CYLINDER (NEW)  
?????????**

**BRAKE PUMP ??????????  
R035054**



**BRAKE LOCKING CLAMP E-6  
E140440**



**TANARG BRAQKE LEVER E-6  
E304030**



**HYDROLIC CONNECTING WASHERS  
R135320 A94**

PART #:

PART #:

PART #:









**Shocks & Shock Mounts**

	<p>FOR RACER</p>	
<p><b>MEGI CONE 45 SHORES S304510 A-71</b></p>		<p><b>ELASTIC TURRET PIN GTE S123010 30-30-2 TANARG S124020 40-35-2</b></p>
		
<p><b>TURRET PIN 60X40 S141010-A14</b></p>		
		
<p><b>FRONT SHOCK ABSORBER R052020 B-1</b></p>		<p><b>SHOCK ABSORBER (REAR) R051010</b></p>
		
<p><b>RING Ø10-25-30 80 SHORES S252510 A72</b></p>		<p><b>RING Ø10-25-5 90 SHORES S252310-A72</b></p>
	<p><b>GTE 582 AND 503 REQUIRES 5-15 BOLT B051510 (A33) AND NUTS B800510 (A68)</b></p>	 <p>TANARG</p>
<p><b>SHOCK MOUNTS 45 SHORES S131010 A-31</b></p>		<p><b>ENGINE MOUNT BUSHING S151010 A-11</b></p>

### Shocks & Shock Mounts

<b>ENGINE MOUNT BUSHING</b> <b>S151010 A-11</b>	PART #:
PART #:	PART #:
PART #:	PART #:
PART #:	PART #:
PART #:	PART #:

**Fasteners**

	<p>ALL TWO PLACE WINGS</p>		
<p>FAST TIGHTENING SCREW 10X110 B230911 A53</p>		<p>E147110 A-60: GTE EYE BOLT 8-68 E159010 A-60: RACER EYE BOLT M8</p>	
	<p>LOWER MAST GTE</p>		
<p>FAST TIGHTENING SCREW 10X72 B230720 A53</p>		<p>FRONT TUBE BOLT ASSEMBLY B230921 A63 SEE KITS FOR IPC</p>	
			
<p>SHORT GOOSE NECK D251510 A26</p>		<p>CUT RINGS H101510 A28</p>	
			
<p>LINK SHACKLE H20310 A26</p>		<p>COPPER EXHAUST NUT F079510 A-55</p>	
			<p>BALL SPINDLE L=35MM: I303510 A25 BALL SPINDLE SAFETY: I303520 A25</p>

**Fasteners**



**NYLSTOP NUT**

- M5: B800510**
- M6: B800610**
- M8: B800810**
- M10: B801010**
- M12: B801210**



**CHC BOLTS**

- 6-30-10 B063210 A34**
- 8-70-15 LOCKING B087110 A39**
- 8-70-20 LOCKING B087210**
- 10-75 B107530 A-72**

**WASHERS**

- 6-14: B810610 A56**
- 8-18: B810810 A56**
- 8-30 B850810 A-58**
- 10-36 B851010 A-58**



**BHC BOLTS**

- 8-85-15 B088515 A-61**

PART #:



**#6, #8, #10**

**DIMPLE WASHERS & SCREWS A90  
FROM B&B PARTS**

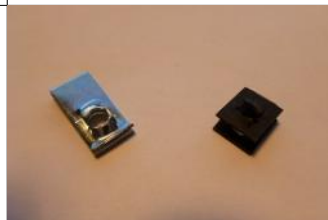

PART #:

**Fasteners**

**NUT 6MM  
R062020 A-18**

**CONTROL BAR LEATHER PROTECTORS  
D074914-R B-13  
D074916-L B-13**

PART #:

PART #:

PART #:

PART #:

PART #:

PART #:

PART #:

**Cloth Parts, Bunji, Roap**



**VELCRO-SAIL FASTENING  
V268010**



**3MM NYLON CORD FOR BATTENS  
V280310**



PART #:



**PULL START ROAP  
F952799**



**TWIN RAID BAGS**

**E166510  
GTE ENGINE SAFETY STRAP**

**E162654 LEFT SIDE  
E162652 RIGHT SIDE**



**E162813  
TWIN SEAT BOX COVER**



**E108610  
TWIN SEAT BOX FRAME**

**E307110  
FRONT SHOCK ABSORBER STRAP**

PART #:

**Gaskets & Seals**

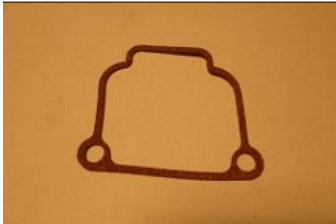

**F830727 A-72  
912 CARB TANK GASKET:**



**GSKT-C-GEARGOX JBM  
C GEARBOX GASKET C23**



**F830720 A-16  
CARB TANK GASKET BING 54:**



**GSKT-B-GEARGOX JBM  
B GEARBOX GASKET C23**



**GSKT-582-EX JBM  
582 EXHAUST GASKET  
F850633 C23**

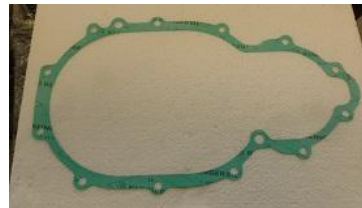

**GSKT-E-GEARGOX JBM  
E GEARBOX GASKET C23**

**GSKT-503-EX JBM  
503 EXHAUST GASKET C23**



**OIL PLUG ON  
TOP OF  
GEARBOX**

**AIR VENT SCREW WASHER  
ROTAX 931-200 A-83**



**GSKT-447-EX JBM  
447 EXHAUST GASKET C23**



**OIL PLUG ON  
BOTTOM OF  
GEARBOX**

**GASKET RING 18.2/24/1  
ROTAX 552-280 A-83**



### Gaskets & Seals



OIL PLUG ON  
BOTTOM OF  
OIL TANK

**GASKET RING C 12X18**  
**250-010 A-83**

PART #:



FOR NIPPLE  
SEALS ON FUEL  
PUMP

**KODIAC GASKET RING 10.2/15/1.5**  
**50-425 A-83**

PART #:



**MIKUNI DUAL CARB REBUILD KIT**  
**CPS PART # 07-01010 B18**

PART #:

PART #:

PART #:

PART #:

PART #:

**Kits**



**ASSEMBLY THAT I CREAATED  
B230921 A63**

**FOR TOP AND BOTTOM OF FRONT TUBE (GTE)**

- 1EA-P310810 A-3 PLASTIC WING HEAD M8**
- 1EA-B087110 A-39 LOCKING SCREW CHC 8-70-15**
- 2EA-B810810 A-56 WASHER 8-18 ±1.5 STAINLESS STL**
- 1EA-B310810 A-55 BUTTERFLY NUT M8- STAINL.STEEL**
- 1EA-I101510 A-28 CUT RING**



**FOR MAST TO FRAME ATTACHMENT (TANARG)**

- 1EA-B311010 STAINLSTEEL WING HEAD M10**
- 1EA-B105217 LOCKING SCREW CHC 10-52-17**
- 1EA-I101510 CUT RING**
- 1EA-P311010 PLASTIC WING HEAD M10**

**BUTTERFLY NUT**

**M8: B310810/A55**

PART #:

PART #:

PART #:

**Kits**



**SCREWING KITS**  
**IXESS 15 B002390 C13**

**Venturi Kit**  
**4-6 Polyurethane hose R133020**  
**1/8 npt \* 3/16 barb Ace Hardware**  
**ASI venture A008710 A-76**  
**GROMMET 6-25-17 ASI P342510 A-19**

PART #:

PART #:

PART #:

PART #:

### Tires and Tubes and Wheels



**INNER TUBE Ø400 BENT VALVE  
R034010**

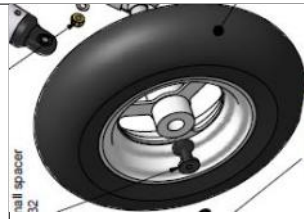

**GTE REAR RIM  
R024110**



**INNER TUBE Ø400 STRAIGHT VALVE  
R034110**

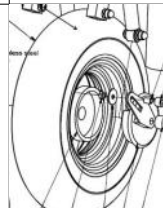

**DOES NOT INCLUDE TORQUE  
PLATE**

**GTE FRONT RIM WITH DRUM  
R024010**



**INNER TUBE TANARG  
R034010**

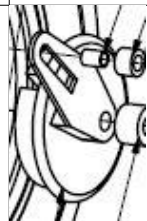

**TORQUE PLATE  
R024020 C7**

PART #:

PART #:

PART #:



**COMPLETE RIM, TIRE, DISK  
ADD \$15 LABOR FOR ASSEMBLY**



**OLD CONFIGURATION**

**Discontinued**

**COMPLETE RIM, TIRE, DISK, AND CALIBER  
LEFT—Y011167-G  
RIGHT—Y011167-D**



**NEW TANARG RIM  
R024112**



**Discontinued**

**OLD TANARG RIM  
R024113**



**NEW TANARG DISC  
R024137**



**Discontinued**

**OLD TANARG DISC  
R024136**



**400 X 8 4PLY KIINGS TIRES  
R012113**



**400x8 DEESTONE TYRE  
R012111**



**16"/650 X 8  
R012150**

**Instruments and accessories**

	<p>USES P342510 GROMET</p>	
<p><b>AIRSPED INDICATOR VENTURI A008711 A-76</b></p>		<p>ALTIMETER G4355 LEAF</p>
		
<p><b>AIRSPED INDICATOR GASKET P342510 A-19</b></p>		<p>AIRSPED INDICATOR G8111US LEAF</p>
	<p>E304150 80MM E304152 86MM E304140 57MM</p>	 <p>USES 399S1 SENDER</p>
<p><b>INSTRUMENT CUTOUT COVERS A-89</b></p>		<p><b>WESTACH WATER TEMP GAGE 2A9-1</b></p>
		
<p><b>UMA VERTICAL SPEED INDICATOR 8-210-20</b></p>		<p>PART #:</p>
<p><b>FALCON VERTICAL SPEED INDICATOR VS12FM-2</b></p>		<p>PART #:</p>

A008710

PART #:	PART #:
PART #:	PART #:
PART #:	PART #:

### **Bearings and Bushings**

---

LOWER BEAM BEARING 012-28 6001 R041230	
ENGINE MOUNT BUSHING S151010	

---

PART #:

PART #:



PART #:	PART #:
PART #:	PART #:
PART #:	PART #:

### Starter Componets



**F852070**  
**KEY CLAMP STARTING ROAP B24**



**F852290**  
**PAWL STARTER B24**



**F938985**  
**LOCKING SPRING B24**



**F852282**  
**STARTING ROAP PULLY B24**



**R062015 LAUNCHING ROAP PULLEY A18**  
**R062020 COMPLETE A18**



**ROTAX 881 890 OR 887 445**  
**REWIND STARTER ASSEMBLY B24**

PART #:

PART #:

PART #:

PART #:	PART #:
PART #:	PART #:
PART #:	PART #:

**Wing Components**



**TECHNORA CORD 2.5MM 4.3M LONG  
V280260 A-83 FOR BIONIX CRANK**



**FRONT LOWER CABLE SLEEVE  
S402010 A-14**



**METAL RAP STOP RING Ø54 (ONE PIECE)  
D263020 A-85**



**METAL RAP STOP RING Ø54 (TWO PIECE)  
D263020 A-85**

BOLT WITH 65MM SHAFT REQUIRED. LENGTH MUST BE 80 MM. THREAD LENGTH IS 10MM.  
AN FHC 6-80-12 (A50) IS IDEAL



**PLASTIC RAP STOP RING Ø54  
D263010 A-24**



**P235020  
BATTEN TIGHTENER A-80**



**LINK SHACKLE  
H20310 A26**



**END CAPS: P201610 2-PLACE B-8  
P201410 RACER B-8**

**D085113-G**  
**A-FRAME FAIRING BIONIX LEFT FOR HANDLE**

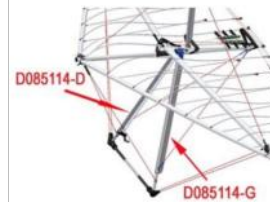

**D085114-G**  
**A-FRAME FAIRING BIONIX LEFT NO HANDLE**

**D085113-D**  
**A-FRAME FAIRING BIONIX LEFT FOR HANDLE**

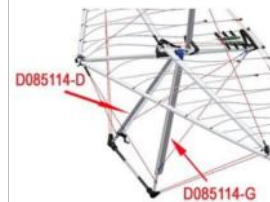

**D085114-D**  
**A-FRAME FAIRING BIONIX RIGHT NO HANDLE**



**3MM Nlon CORD FOR BATTENS**  
**V280310**



**D085011-G**  
**A-FRAME FAIRING IXESS XP KISS RIGHT**



**P233010 A-8 STOP BATTEN**  
**I351410 A-27 RIVET 4-16 ALUMINUM**



**D085110-G**  
**A-FRAME FAIRING IXESS XP KISS LEFT**



**BATTEN TIPS**  
**P231010**



**BLACK AND RED BATTEN SCREW**  
**P235015 A-84**

**Wing Components**



**I112510**  
SHACKLE SS 25MM A26

KINGPOST FOOT  
D256010 A72



**D251610**  
LONG GOOSE NECK A26



STRIP WOTH HOLES  
I200910/I200610 A26



**D251510**  
SHORT GOOSE NECK A26



**D074815**  
LEATHER TAB A93

**D255510**  
LUFF PULLY A26



**D261211**  
Hang point sleeve 80mm Ø54 C21



**D252242**  
U APR 80MM C21



**D252240**  
U APR 80MM C21

**Discontinued**

	<b>NEOPRENE</b>
<b>D070012 BIONIX 13 C-26</b> <b>D070010 BIONIX/NUVIX 15 C-26</b>	PART #:
PART #:	PART #:
PART #:	PART #:

**Cable Hardware**

<b>Adjustable Sheath Stop R144310 A-17</b>	
PART #:	PART #:
PART #:	PART #:



**Gerbing Heated Clothes**

**Controllers, vest, gloves D11**

PART #:

PART #:

PART #:

PART #:

PART #:

**Seat belts and harness**

<b>Front seat belt GTE</b> <b>E165011</b>	<b>Rear seat belt GTE</b> <b>E165211</b>
<b>3-Point Safety Belt Reel</b> <b>R071211</b>	<b>Plastic Guide</b> <b>P314010</b>
<b>Safety Belt Buckle</b> <b>R071011</b>	<b>Long seat belt Tanarg</b> <b>E307075</b>
<b>Safety Belt Closing</b> <b>R071014</b>	<b>Short seat belt Tanarg</b> <b>E307073</b>
<b>PART #:</b>	<b>PART #:</b>

## Lights and Strobes

 <p><b>Beehive Nav Lights D2</b></p>	<p><b>Nav light Installation Supplies D10</b></p>
<p>PART #:</p>	<p>PART #:</p>
<p>PART #:</p>	<p>PART #:</p>

## Propellers

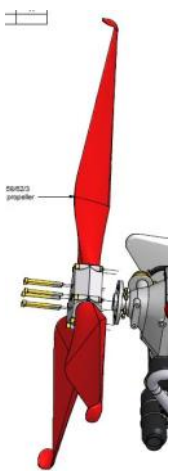

For Tanarg ES

**R108752**  
**HELICE ARPLAST 158/62/3 (Curved Tip)**

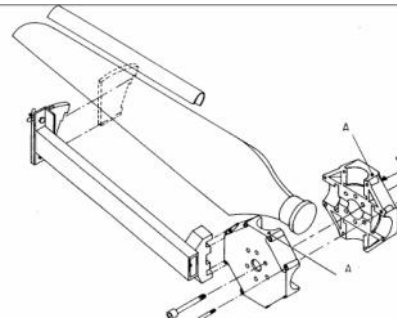

**R108770**  
**HELICE ARPLAST 166/48/4**

For Rotax 582 4-blade

**R**  
**Neuform Propeller**



**F007620**  
**912 Propeller mounting stud A83**



**Spacer for ivo 2 blade prop A68**

**Frame Hardware**

<b>GTE footrest reinforcement E142510 B-10</b>	
PART #:	PART #:
PART #:	PART #:

**Hoses and Lines and Fittings**

	<p>10.5" per carb</p>	<p>Used for pitot</p>
<p>Durite Air Tubing R138851</p>		<p>4-6 Polyurethane hose R133020</p>
<p>Airspeed indicator venturi A088437</p>		 <p>Used for ASI Fitting</p> <p>Teat 3/16 x 1/8 pipe Ace Hardware</p>
 <p>Plastic T 6-6-6 R130550 A92</p>		 <p>Teat 1/8 x 1/8 pipe ACE 454114 A92</p>
 <p>912 Drain Fitting E306100 A18</p>		 <p>Teat 06 1/8 pipe R130455-leaf A92</p>
 <p>Elbow 90 x 1/8 R130430 A94</p>		 <p>Teat 06 x 1/4 pipe H7303 -leaf A93</p>

**Hoses and Lines and Fittings**



**Teat 10 1/4  
R130480 A92**



**Boss M 1/4  
R130495 A92**



**Reducer F/M 1/4 1/8  
R130500 A94**



**Metal T 8-8-8  
R150565-? A92**



**LEAF 10161  
DELRIN PRIMER TAP 1/4 X 1/4 X 1/8 A92**



**R130550  
90° PLASTIC ELBOW Ø10 A16**



**LEAF H7275  
DELRIN 1/4 TEE FUEL A92**



**R130554  
90° PLASTIC ELBOW Ø6 A16**



**LEAF H7277  
AIRCRAFT SPRUCE 05-01052  
DELRIN 1/4 Y FUEL A94**

### Hoses and Lines



**R130410**  
**Fuel shut-off**



**R**  
**90° ELBOW**



**R130420**  
**Y brass F 1/4 A-94**

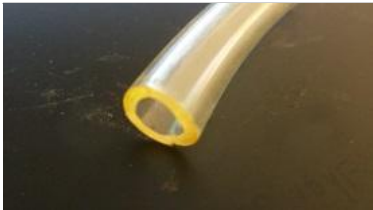

**1/2"OD/1/4"ID**  
**PART #:**



**1/4"OD/1/8"ID**  
**PART #:**



**Hoses and Lines**

	<p><b>Carb Heater Hose</b></p>		<p><b>FUEL LINE</b></p>
<p><b>R132710</b>  <b>DURITE CARBOPRESS 08-14</b>  <b>14MM OD/8MM ID</b></p>		<p><b>R132512</b>  <b>DURITE CARBOPRESS 06-12</b>  <b>12MM OD/6MM ID</b></p>	
	<p><b>Aeroquip AQP SH925-8</b>  <b>DN12 &gt;CM,SY,CM</b>  <b>912 OIL LINES</b></p>		<p><b>Oil Overflow Tube</b></p>
<p><b>R132850</b>  <b>OIL TUBING 12.7-19</b>  <b>19MM OD/12.7MM ID</b></p>		<p><b>R132812</b>  <b>DURITE CARBOPRESS 10-17</b>  <b>17MM OD/10MM ID</b></p>	
	<p><b>Fuel water drain</b>  <b>Water overflow tank</b></p>		<p><b>Sight Tube</b></p>
<p><b>R133024</b>  <b>POLYURETHANE 6-9MM</b></p>		<p><b>R133028</b>  <b>POLYURETHANE 10-16MM</b></p>	
	<p><b>Hi pressure hose on 582 head Eaton Synflex 3130-03</b></p>		<p><b>Airspeed Indicator</b></p>
<p><b>R132410</b>  <b>INTERLACED FIBER HOSE 05-11MM</b>  <b>13/32"OD/3/16ID</b></p>		<p><b>R133020</b>  <b>POLYURETHANE 04-6MM</b>  <b>6MM OD/4MM ID</b></p>	
	<p><b>3/8"OD/1/4"ID</b>  <b>PART #:</b></p>		<p><b>PART #:</b></p>

### Radios, Intercoms, and Accessories



**AirKit Antenna**



**E166805 A81  
Radio Fixing Strap**



**E304090 A-90  
ICA3 Radio Support**



**A220150 A-90  
ICA6 Radio Support**

PART #:

PART #:

### RAM Mount Hardware



**496/396/296 GPS holder C26**  
**www.rammount.com RAM-HOL-GA7U**



**Magellen 315 GPS holder C26**  
**www.rammount.com RAM-HOL-MA1**



**RAM Long Bracket**  
**LEAF G8180**

PART #:



**RAM Ball**  
**LEAF T3072**

PART #:



**RAM EZ-ON/OFF Mount Assembly**  
**www.rammount.com for antenna**

PART #:

### Steering Components

<b>E302160</b> <b>Rudder Stop Nut</b>	

PART #:

PART #:

### Windsheilds



**R201100**  
**Clipper/buggy Windsheild**



**R201103**  
**GTE Windsheild**



**R201105**  
**Tanarg Windsheild (low profile)**



**R201106**  
**Tanarg Windsheild (High profile)**



**R201108**  
**Skypper Windsheild (Low profile)**

PART #:



**R201109**  
**Skypper Windsheild (High profile)**

PART #:

### Seats and Hardware



BOX FIXING STRAP  
E307105 A87



V911006 MALE  
V911005 FEMALE

PLASTIC BUCKLE 20MM A81



V941000 PRESS STUD MALE A81  
V941005 PRESS STUD FEMALE

**Parachute Parts**



**PLAKPARA  
BRS PARACHUTE MOUNTING PLATE C-25**



**PARAB 1024  
BRS ROCKET METAL BASE PLATE C-25**



**PARAB 1028  
BRS ROCKET SUPPORT C-25**



**BRS 005061-01  
QUICK LINK 1/2 SS C-25**



**PART?? C-25**



**PART?? C-25**

**FIBERGLASS PARACHUTE DOOR  
MR202603**



**PARAB 1010  
FASTENING STURRIP GTE B-11**



**PARAB 1015  
BRS MOUNTING PLATE GTE B-11**



**PARAB 1020  
BRS PARACHUTE SUPPORT 40X20 C-25**

**Parachute Parts**

WHEEL PANT GTE TREK  
MR202095 RIGHT  
MR202095 LEFT

PART #:

PART #:



### Mast and Hardware



**E110910/E110920 B-14**  
**FRONT TUBE FIXING PLATE**



**LAUNCHING PULLEY**  
**R062020 A-18**



**E134010**  
**ARP LOCK WASHER 80MM A12**

PART #:

PART #:

**WATER COOLING SYSTEM COMPONENTS**



**FP922075**  
**RADIATOR CAP WITH GASKET A-94**

**582 GTE water hoses**

- R131550 - WATER HOSE 2X90 2X150 -GTE
- R131560 - WATER HOSE 1X90 -GTE
- R132410 interlaced fibres hose Ø5-11 lgth:300mm  
 Eaton Synflex 3130-03
- R131580 WATER HOSE Ø25 ID length 100mm
- Rotax 922 521 molded hose 25/180 degree



**E304078**  
**RADIATOR DEFLECTOR**

**912 Clipper water hoses**

- R131565 912 water rubber hose 100° & 45°
- R131560 1/2 water rub.hose 1x90
- R131560 1/2 water rub.hose 1x90
- R131585 water rub.hose Ø30in meter
- R131568 912 water rub.hose 2x135°

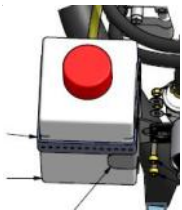

**CAP B19**

**F922327**  
**WATER OVERFLOW TANK B19**

**582 Tanarg water hoses**

- FXXXXXXXX - WATER HOSE ROTAX 582
- R131575 - WATER HOSE N1
- R131578 WATER HOSE N2
- R131576 582 expansion tank water hose

**912 Tanarg water radiator and hoses**

- [R131510 RADIATOR \(ALSO FOR GTE\)](#)
- [R131585 180MM hose](#)
- [R131585 75MM](#) hose
- [R131572](#) water hoses (2)
- R131570 hose
- R131595 hose Ø25 (80mm)

**F922312**  
**EXPANSION TANK ASS A-93**



**E144716**  
**MOUNTING BRACKET A70**

### **Air Filters,Silencer,Hose**

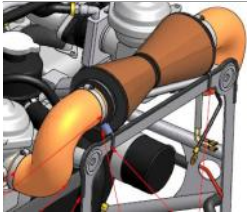

**F825551**  
**Air filter 054 for tanarg and skypper**  
**R138851 Skypper& tanarg**  
**orange air hose Ø50 260mm long**



**F825511**  
**Air filter for intake silencer on 2-stroke**  
**F825659**  
**INTAKE SILENCER ASSY.LOW FILTR**



**F825551 C-16**

**Sp-2704 from leaf**  
**or spruce F825551**  
**For bing 54 carb**  
**intakes manifold**

PART #:

PART #:

**Exhaust and Parts**



**F398795**  
**EXHAUST SPRING A-31**

**E144716**  
**MOUNTING BRACKET A70**

### Rubber Products

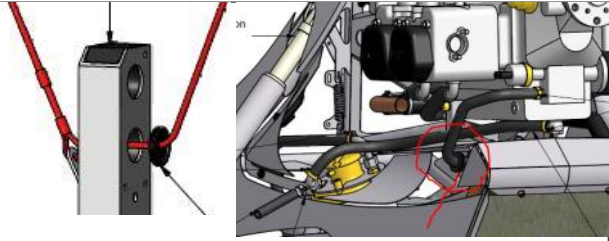
 <p><b>P343510</b> <b>GROMMET 28-34-8 A8</b></p>	
	PART #:
PART #:	PART #:

### Dual Controls and Training Bars

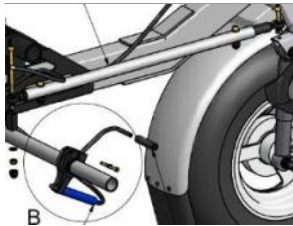

COMPLETE KIT (GREY  
TUBE + LEVER + CABLE)

**U402500-G**  
**GREY DUAL CONTROL KIT**



**U390030-A15072**  
**Training Bars**

PART #:

PART #:

PART #:

PART #:

PART #:

PART #:

PART #:

### Landing Gear Components



**E303020**  
**UNDERCARRIAGE BUSHING**

PART #:

PART #:

PART #:

PART #:

PART #:

PART #:

PART #:

### Starter System Components



**LAUNCHING PULLEY**  
**R062020 A-18**



**CONTROL BAR LEATHER PROTECTORS**  
**D074914-R B-13**  
**D074916-L B-13**

PART #:

PART #:

PART #:

PART #:

PART #:

PART #:

PART #:



\_\_\_\_\_

\_\_\_\_\_

\_\_\_\_\_

\_\_\_\_\_

\_\_\_\_\_

\_\_\_\_\_

**Front End, Fenders, Etc.**



**R200601 (OLD R081010)  
METAL MUD GUARD GTE C24**



**R200601 (OLD R081020)  
PLASTIC MUD GUARD C24**



**R081220  
MUD GUARD FLAP C24**

PART #:

PART #:

PART #:

PART #:

PART #:

PART #:

PART #:

---

---

---

### Rubber Products



**JBL ROTAX 503 CARBURETOR SOCKET**  
Z000002-503 A73



**JBL ROTAX 582 CARBURETOR SOCKET**  
Z000002—582 A87



**JBL Dual Carburetor Intake Silencer Boot.**  
Z000003-A70



**R101010**  
**FOOTREST JACKET**



**JBL RUBBER BOOTS FOR IGNITION WIRES**  
Z000004-A66



**AIRSPEED INDICATOR GASKET**  
P342510 A-19

PART #:

PART #:

PART #:

R132812durite huile 12,7x19

PART #:

PART #:

 Organization

AIR CREATION

PART #:

Primary Business Address PART #:

Your Address Line 2

Your Address Line 3

Your Address Line 4

Phone: 555-555-5555

Fax: 555-555-5555

E-mail: someone@example.com

PART #:

PART #:

L:650mm

oil hose Ø12,7x19 lgth.:650mm

R132850

**DURITE CARBOPRESS 10-17**  
**17MM OD/10MM ID**